



B662



P513-731

B-Series Double cylinder deadbolt, small format Interchangeable Core
 Cerrojo cilíndrico doble serie B, Núcleo pequeño intercambiable
 Pêne dormant à double cylindre de série B, Coeur interchangeable de petite dimension

Installation Instructions
 Instrucciones de Instalación
 Instructions d'installation

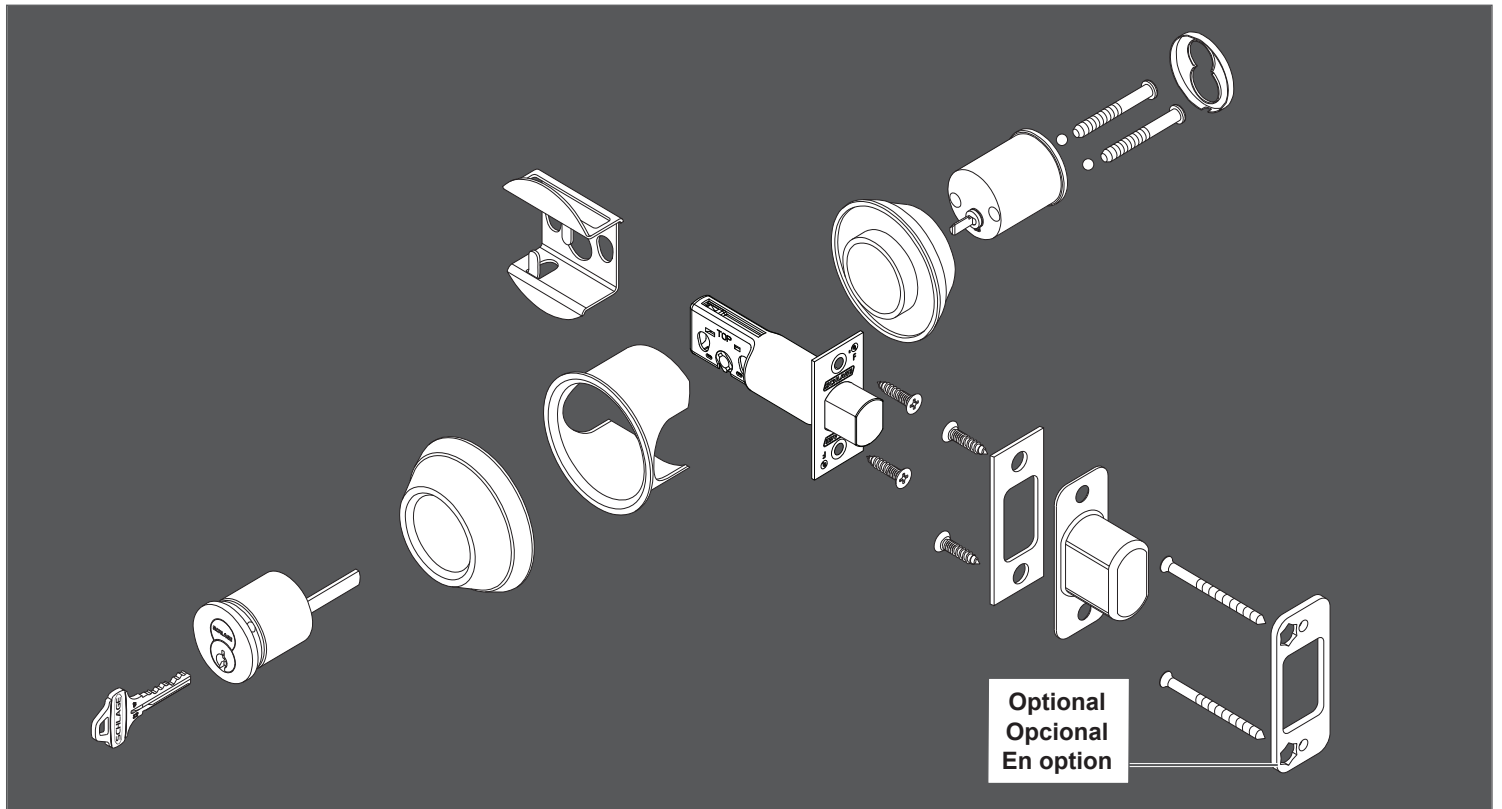

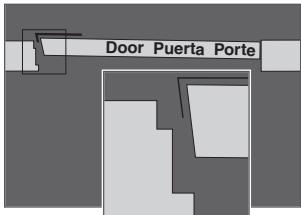
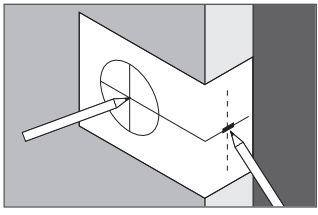
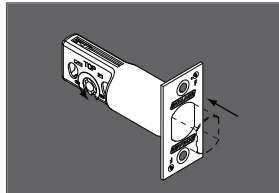
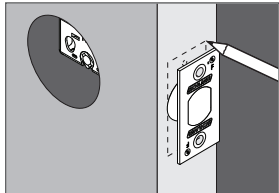
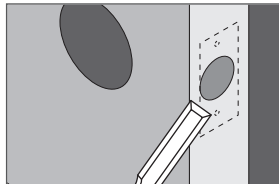
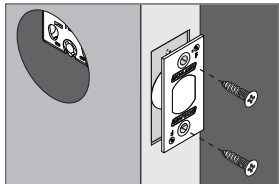
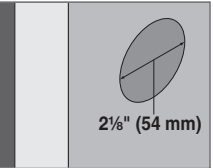
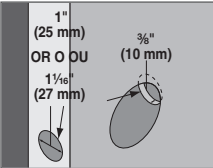
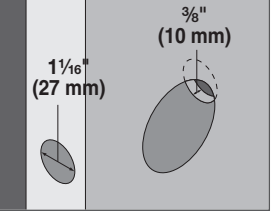
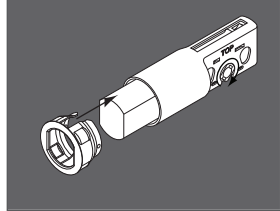
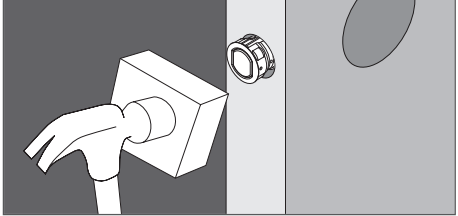
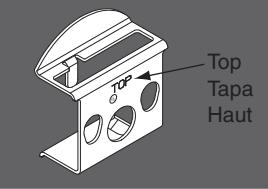
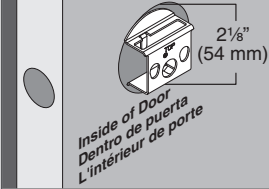
<p>1 Mark door with template.</p>	<p>4 Install deadbolt</p>
<p>Marque la puerta con la plantilla.</p>	<p>Instalación del cerrojo de seguridad</p>
<p>Tracez la gabarit sur la porte.</p>	<p>Installez le pêne dormant</p>
<p>a  Door Puerta Porte</p> <p>b </p>	<p>a </p> <p>b </p> <p>c </p> <p>d </p>
<p>2 Drill 2 holes.</p>	<p>Install circular drive-in deadbolt.</p>
<p>Taladre (2) agujeros.</p>	<p>Instale el cerrojo circular de seguridad.</p>
<p>Tracez la gabarit sur la porte.</p>	<p>Installez le pêne dormant circulaire.</p>
<p>a  2 1/8" (54 mm)</p> <p>b  1" (25 mm) OR 1 1/16" (27 mm) 3/8" (10 mm)</p> <p>1" (25mm) for deadbolt, or 1 1/16" (27 mm) for circular bolt 1" (25mm) para cerrojo de seguridad, o 1 1/16" (27 mm) para perno circular 25 mm (1 po) pour le pêne dormant, ou 27 mm (1 1/16 po) pour boulon rond</p>	<p>a  1 1/16" (27 mm) 3/8" (10 mm)</p> <p>b </p> <p>c </p>
<p>3 Install Fire Cup (UL Only, 2 1/8" through bore only).</p>	<p> Top Tapa Haut</p> <p> Inside of Door Dentro de puerta L'intérieur de porte 2 1/8" (54 mm)</p>

5 Prepare door jamb.

Prepare la jamba de la puerta.

Préparez le jambage de la porte.

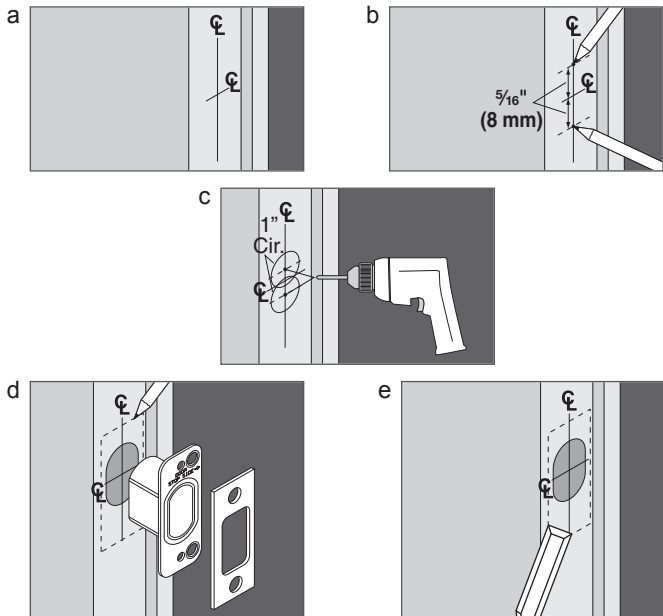

6 Install Strike Assembly.

Instale el conjunto de piezas del recibidor.

Installez les pièces de la gâche.

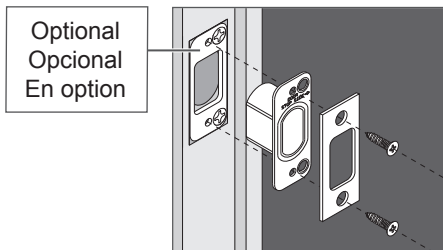

7 Install Outside Lock.

Instalar la cerradura exterior.

Installez le verrou extérieur.

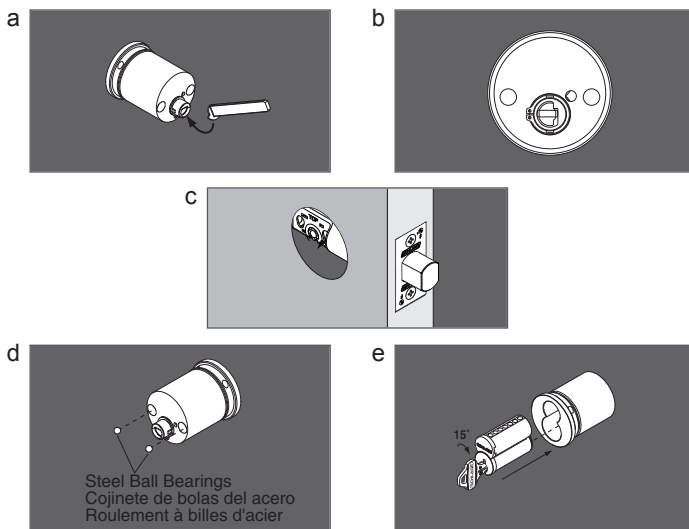

⚠ IMPORTANT NOTES ⚠

Do not use metal shield in existing 1½" (38 mm) hole installations.

Si utiliza un agujero previamente taladrado de 38mm, no haga uso de la rodela metálica incluida.

S'il existe déjà un trou de 38mm, ne pas utiliser la gaine de sécurité fournie.

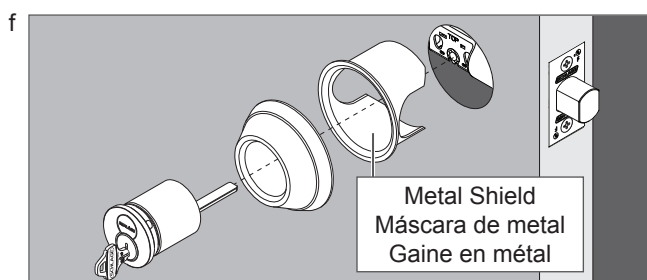

8 Install inside lock

Instale la cerradura interior

Installez le verrou intérieur

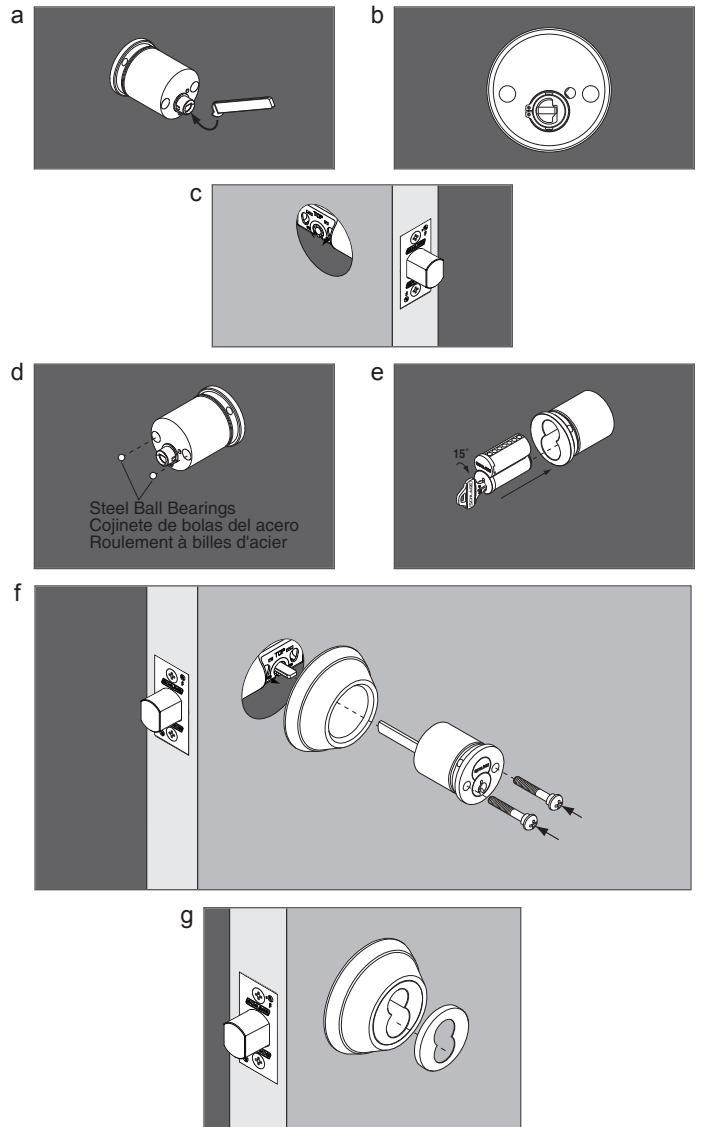

Customer Service Servicio al cliente Service à la clientèle

1-877-671-7011

www.allegion.com/us

ALLEGION

© Allegion 2014
Printed in U.S.A.
P513-731 Rev. 01/14-c